

Accuphase

INTEGRATED STEREO AMPLIFIER

E-306V

- Parallel push-pull output stage delivers 2 x 100 watts of quality power into 8 ohms
- Current feedback topology assures stable operation and great sound quality
- Logic-controlled relays for shortest signal paths
- Separate switch allows independent use of preamplifier and power amplifier
- Balanced inputs
- Analog record playback possible with option board
- Supplied remote commander



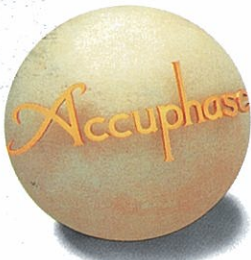

Welcome to the world of exhilarating sound. Integrated amplifier with current feedback topology creates a totally realistic sound stage. Wide-band power transistors in parallel push-pull configuration deliver 140 watts/channel into 4 ohms, 120 watts/channel into 6 ohms or 100 watts/channel into 8 ohms. Option board slot allows playback of analog records with impeccable sound quality.

Based on the highly successful Accuphase integrated amplifier E-306, the model E-306V is a further refined and enhanced instrument for totally faithful music reproduction. It reflects the extensive experience Accuphase has gained in building superb separate-type amplifiers. Every single aspect has been honed to deliver optimum performance.

An integrated amplifier provides various advantages such as convenient operation and modest space requirements. However, because its overall gain is very high, even the slightest interference or crosstalk at the input can have a considerable effect on the sonic result. To preclude any possibility of this, the E-306V is designed to achieve total electrical and structural separation of the preamplifier and power amplifier sections. These two parts operate as if they were entirely separate components. Each has its own power supply and dedicated regulator circuitry. A switch even allows using the preamplifier and power amplifier independently.

Accuphase's highly acclaimed current feedback topology is used in both the preamplifier and power amplifier. This innovative principle eliminates phase shifts in the upper frequency range and assures stable operation and uniform frequency response which does not change with gain. Phase compensation can be kept at a minimum, and high amounts of negative feedback with their associated disadvantages are no longer required, resulting in excellent transient response, with superb sonic transparency and detail.

The power amplifier output stage employs a parallel push-pull configuration, using power transistors designed for high-current audio applications. Drive capability especially with critical low-impedance loads has been dramatically improved. The preamplifier section is designed around a current feedback line amplifier with 20 dB gain. It is driven by a dedicated toroidal power transformer which eliminates any possibility of interference from the power amplifier.

A total of seven input positions are provided, including two balanced inputs for professional-quality noise-free signal transmission. Flexibility is further

enhanced by an option board slot on the rear of the amplifier which accepts for example an analog disc input board for MM or MC cartridges, allowing reproduction of analog records with outstanding sonic quality.

The tape enthusiast will welcome connectors for two tape recorders, with easy dubbing in both directions. Tone controls, loudness compensation, and a supplied remote commander are further advantages. The newly designed front panel is dominated by the input selector and volume control knob on both sides, with large power meters arranged in the center. Its sophisticated design makes the E-306V a pleasure to look at as well as a delight to listen to.

Parallel push-pull output stage delivers quality power: 140 watts/channel into 4 ohms, 120 watts/channel into 6 ohms or 100 watts/channel into 8 ohms

Figure 1 shows a circuit diagram of the power amplification stage. The power transistors are designed for audio applications and have been selected for optimum frequency response, forward-current transfer ratio linearity, and switching performance characteristics.

The devices are connected in parallel and mounted directly on a large heat sink for efficient dissipation of thermal energy. This allows the E-306V to deliver ample power output, amounting to 140 watts into 4 ohms, 120 watts into 6 ohms, or 100 watts into 8 ohms per channel.

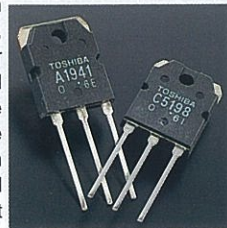

Current feedback circuit topology in power amplifier and line amplifier sections prevents phase shifts

When the gain of an amplifying circuit increases, frequency response, i.e. the bandwidth that can be handled by the amplifier, becomes more narrow. To counter this effect, a commonly employed technique

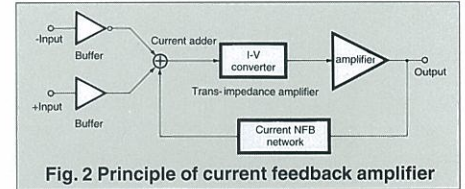

Fig. 2 Principle of current feedback amplifier

called negative feedback (NFB) routes part of the output signal back to the input. Conventional amplifiers employ voltage NFB, whereby the output voltage is used for the feedback loop. In the E-306V however, the signal current rather than the voltage is used for feedback. Figure 2 shows the operating principle of this circuit. At the sensing point of the feedback loop, the impedance is kept low and current detection is performed. An impedance-converting amplifier then converts the current into a voltage to be used as the feedback signal. Since the impedance at the current feedback point (current adder in Figure 2) is very low, there is almost no phase shift. Phase compensation can be kept to a minimum, resulting in excellent transient response and superb sonic transparency.

Figure 3 shows frequency response for different gain settings of the current feedback amplifier. The graphs demonstrate that response remains uniform over a wide range.

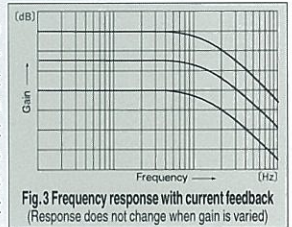

Fig. 3 Frequency response with current feedback (Response does not change when gain is varied)

Discrete-type line amplifier for superior sonic purity

The line amplifier whose circuit diagram is shown in Figure 4 is entirely built from discrete parts, to assure optimum performance. A differential pure complementary push-pull circuit is used, with an emitter follower output stage. Current feedback topology further enhances circuit operation and reduces the need for phase compensation, resulting in effortless, utterly natural and transparent sound.

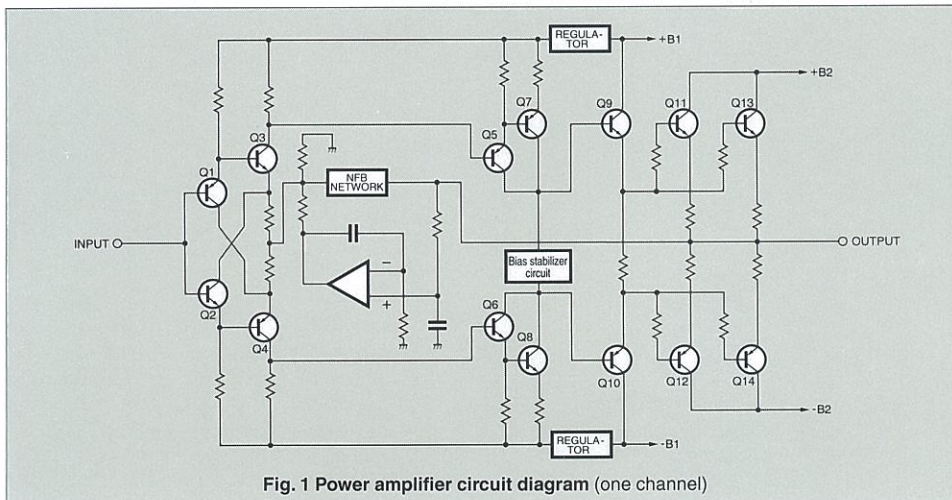

Fig. 1 Power amplifier circuit diagram (one channel)

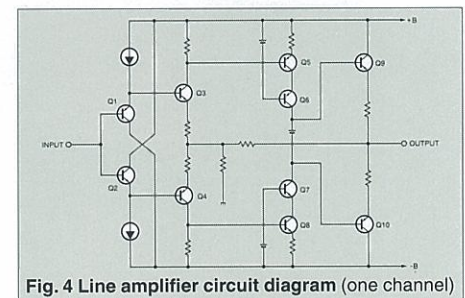
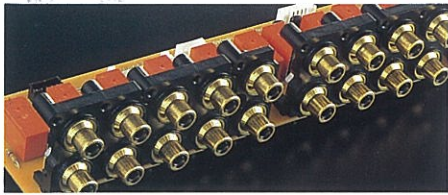

Fig. 4 Line amplifier circuit diagram (one channel)

Highly reliable logic-controlled relays

Program source switching is performed by logic-controlled relays which are arranged to permit the shortest possible signal paths. The hermetically sealed relays are high-quality types developed specifically for demanding communication applications. The contacts are twin crossbar types

plated with gold for minimum contact resistance and outstanding long-term reliability.



Tone controls use summing active filters for pure sound

The tone control circuitry in the E-306V was specially designed with summing active filters such as found in high-quality graphic equalizers. Figure 5 illustrates the operation principle of this circuit. The flat signal is passed straight through, and only when an adjustment is required, the characteristics are created at F1 and F2 and added to the signal, thereby producing the desired change. This design provides efficient control without diluting signal purity.

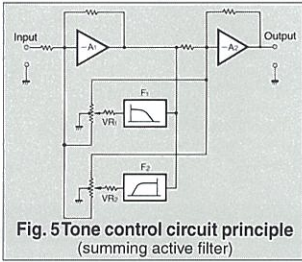

Heavy-duty speaker terminals

The oversize speaker terminals are made of extruded high-purity brass material, which also accept heavy-gauge speaker cable.

Robust power supply with large power transformer and high filtering capacity

The power supply plays a vital role as the source of energy for the power amplifier section. The E-306V uses a large 500 VA power transformer and two massive electrolytic capacitors rated for 22,000 μ F each. This assures ample reserves also for reproduction of demanding bass passages. The preamplifier section has its own dedicated power supply circuitry, to



prevent the possibility of interference via the power supply line.

Large, direct-reading peak power meters

The large analog power meters have a peak hold function which lets you easily monitor the output level of the rapidly fluctuating music signal. Thanks to logarithmic compression, the meters cover a wide dynamic range.

SEPARATE switch allows independent use of preamplifier and power amplifier sections

Separate preamplifier outputs and power amplifier inputs, controlled by a selector switch, allow use of the preamplifier section and the power amplifier section as separate components.



■ Assembly with current feedback discrete type line amplifier, regulated power supply and other parts

■ Supplied remote commander RC-22 allows volume adjustment and input source switching.

■ Power amplifier assembly with parallel push-pull output devices mounted to large heat sink and current feedback amplifier circuitry

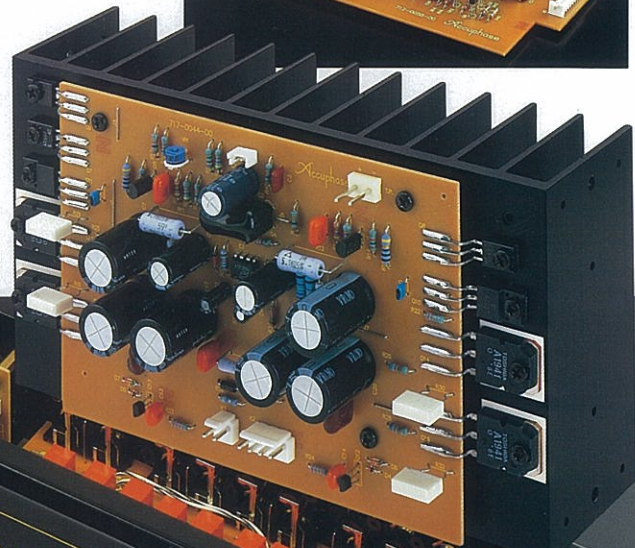
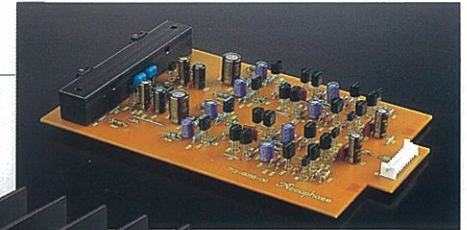

Versatile input configuration including balanced connectors

The input selector of the E-306V controls a total of eight positions, including two tape recorders and a position for an optional input board installed in the rear-panel slot. Two of the standard inputs are designed for balanced connections which are impervious to externally induced noise, ensuring signal transmission with optimum sonic purity.



Remote commander allows source switching and volume adjustment

The high-quality volume control in the E-306V can also be operated via the remote control from any convenient location. The control also allows input source switching.

Option Boards

The rear panel of the E-306V provides a slot in which an optional input board can be installed easily. Two types of boards, as shown below, are available.

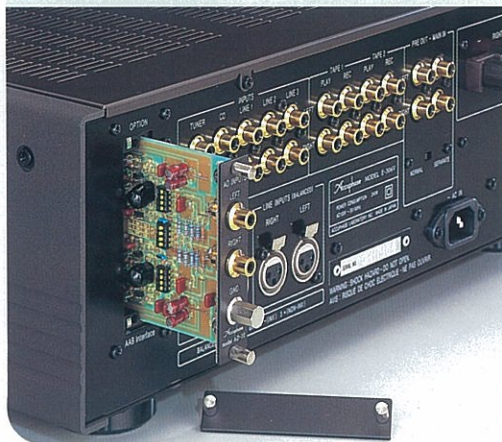

Line Input Board LINE-10

This option board provides an additional set of conventional line inputs which can be used to connect a CD player, tuner, or other component with analog output.

Analog Disc Input Board AD-10

This board contains a high-performance, high-gain phono equalizer. The board can be used with any type of phono cartridge.

Internal DIP switches control MM/MC operation, MC input impedance, and subsonic filter on/off.

MM	Gain	: 29 dB
	Input impedance	: 47 kilohms
MC	Gain	: 60 dB
	Input impedance	: 10/30/100 ohms (selectable)

★ Both boards use the AAB (Accuphase Analog Bus) interface.

FRONT PANEL

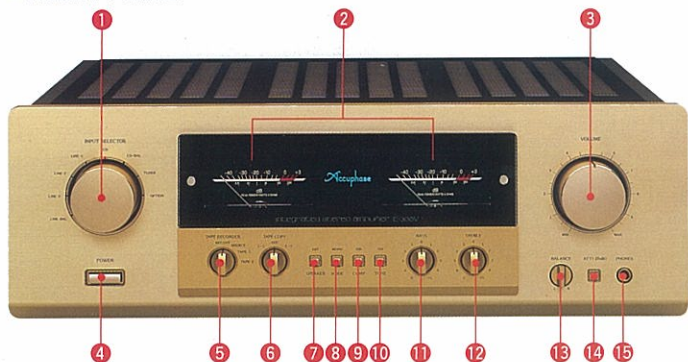

REAR PANEL

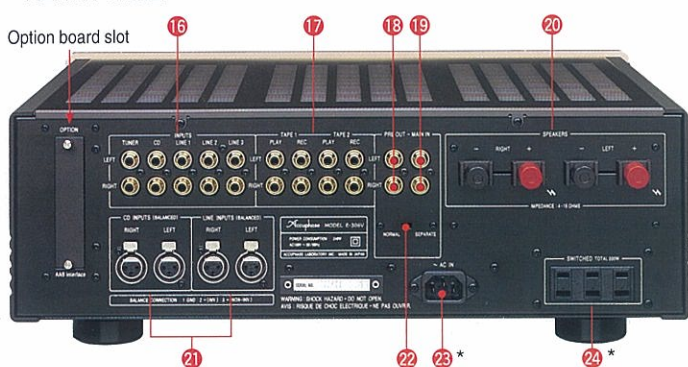

- 1 Input selector
LINE-BAL LINE-3 LINE-2 LINE-1
CD CD-BAL TUNER OPTION
- 2 Left/right output meters
(dB scale, direct-reading watt scale)
- 3 Volume control
- 4 Power switch
- 5 Recording output/tape monitor selector
REC OFF SOURCE TAPE-1 TAPE-2
- 6 Tape copy selector 1→2 OFF 2→1
- 7 Speaker ON/OFF switch
- 8 Mode switch
- 9 Loudness compensator switch
- 10 Tone control ON/OFF switch

- 11 Bass control
- 12 Treble control
- 13 Balance control
- 14 Attenuator switch
- 15 Headphone jack
- 16 Line inputs
- 17 Tape recorder inputs and outputs
- 18 Preamplifier outputs
- 19 Power amplifier inputs
- 20 Left/right speaker output terminals
- 21 CD/LINE balanced inputs
- 22 Preamplifier/power amplifier separate switch
- 23 AC inlet *
- 24 Switched AC outlets *

Remarks

* The shape of the AC inlet, plug of the supplied power cord, and AC outlet depends on the voltage rating and destination country.

* These switched AC outlets may not be supplied depending on the safety standards or regulations applicable in the particular country to where the unit is destined.

- Supplied accessories
- AC power cord
 - Remote commander RC-22

※ Specifications and design subject to change without notice for improvements.

E-306V GUARANTEED SPECIFICATIONS

(Guaranteed specifications are measured according to EIA standard RS-490.)

- **Continuous Average Output Power** 140 watts per channel into 4 ohms
120 watts per channel into 6 ohms
100 watts per channel into 8 ohms
(both channels driven, 20 ~ 20,000 Hz)
- **Total Harmonic Distortion** 0.035%, with 4 to 16 ohms load (both channels driven)
- **Intermodulation Distortion** 0.01%
- **Frequency Response** MAIN INPUT : 20 ~ 20,000 Hz +0, -0.2 dB
(for rated output)
2 ~ 150,000 Hz +0, -3.0 dB
(for 1 watt output)
HIGH LEVEL INPUT : 20 ~ 20,000 Hz +0, -0.2 dB
(for rated output)

- **Damping Factor** 100 (with 8-ohm load, 50 Hz)
- **Input Sensitivity, Input Impedance**

Input	Sensitivity		Input impedance
	For rated output	For 1 W output (EIA)	
HIGH LEVEL INPUT	113mV	11.2mV	20kΩ
BALANCED INPUT	113mV	11.2mV	40kΩ
MAIN INPUT	1.13V	112mV	20kΩ

- **Output Voltage, Output Impedance** PRE OUTPUT: 1.13 V, 50 ohms
(at rated continuous average output)
- **Gain** MAIN INPUT → OUTPUT : 28 dB
HIGH LEVEL INPUT → PRE OUTPUT : 20 dB
- **Tone Controls** Turnover frequency and adjustment range
BASS : 300 Hz ±10 dB (50 Hz)
TREBLE : 3 kHz ±10 dB (20 kHz)
- **Loudness Compensation** +6 dB (200 Hz) (Volume control setting -30 dB)
- **Signal-to-Noise Ratio**

Input	Input shorted, IHF-A weighting	S/N ratio (EIA)
	S/N ratio at rated output	
HIGH LEVEL INPUT	104dB	80dB
BALANCED INPUT	88dB	80dB
MAIN INPUT	122dB	100dB

- **Power Level Meters** Logarithmic compression, peak reading meters dB and direct watt-reading (8-ohm load) scale
4 ~ 16 ohms
- **Load Impedance** Suitable impedance: 4 ~ 100 ohms
- **Stereo Headphones** 100 V, 120 V, 220 V, 230 V, 240 V
(Voltage as indicated on rear panel) AC, 50/60 Hz
- **Power Requirements** 50 watts idle
240 watts in accordance with IEC-65
- **Maximum Dimensions** Width 475mm (18-11/16")
Height 170 mm (6-11/16")
Depth 418 mm (16-7/17")
- **Weight** 20.5 kg (45.2 lbs) net
25.5 kg (56.2 lbs) in shipping carton

- **Supplied Remote Commander RC-22** Remote control principle : infrared pulse
Power supply : 3 V DC (IEC R6 batteries x 2)
Dimensions : 45 x 136 x 18 mm
Weight : 85 g (including batteries)

Accuphase
ACCUPHASE LABORATORY INC.

PRINTED IN JAPAN A9810Y 851-0154-00 (AD1)